



LIFTS + CANOPIES



STORE AND PROTECT

Porta-Dock offers a complete line of aluminum boat and pontoon lifts designed and engineered with features that make each lift and canopy work with your boat.

FOR ANY SIZE BOAT VERTICAL LIFTS

Constructed of high-quality aluminum for maximum strength and durability, Porta-Dock lifts are rustproof, corrosion resistant, and unaffected by weather conditions or UV rays. In addition, bunk assemblies adjust both vertically and horizontally for maximum boat support.



HANG WITH
THE WHOLE
CREW



FREE STANDING CANOPY



LIFT MODEL	BEAM	BED LENGTH	MAX CAPACITY	WEIGHT
30113 Standard	112.5"	9'	3000 lbs	335 lbs
30120 Standard *	120"	9'	3000 lbs	345 lbs
40120 Standard *	120"	9'	4000 lbs	395 lbs
40120 Long *	120"	11'	4000 lbs	405 lbs
45120 Long	120"	11'	4500 lbs	469 lbs
50120 Long *	120"	11'	5000 lbs	482 lbs
60120 Long	120"	11'	6000 lbs	520 lbs
70120 Long	117.5"	11'	7000 lbs	855 lbs
50120 Extra Long *	120"	15'	5000 lbs	529 lbs
60120 Extra Long	118"	15'	6000 lbs	570 lbs
70120 Extra Long	117.5"	15'	7000 lbs	932 lbs
70144 Extra Long / Wide	144"	15'	7000 lbs	978 lbs

* Also available as a shallow water lift, see page 36

Advantages

- All four legs are adjustable, making it easy to set proper depth (optional screw legs available)
- Extruded aluminum bunk assemblies with ribbed polyurethane bunk covers on deluxe pontoon bunks (FLB/FPB)
- Chain or gear drive winch comes standard with self braking for safe and easy operation
- Low maintenance
- Maintenance free bunks available on 3000-7000 lb. lifts
- Stainless steel cables and enclosed pulleys
- Lightweight aluminum frame
- 66" maximum lifting height
- Lift wheel included on all base models up to 6000 lbs
- Winch motors standard on 7000 lbs lifts
- Winch motors available for all lift models
- Canopies available in multiple sizes and colors

FREE STANDING CANOPY

Porta-Dock free standing canopies provide protection from the elements when a traditional lift is not needed. Perfect for pontoons with Sea-Legs™.

SHALLOW WATER VERTICAL LIFTS

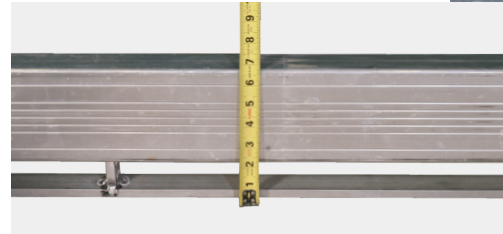

Shallow Water Lift Solution

The bed of Porta-Dock's shallow water lifts sit at only 6 3/4" off the lake bottom.

CANTILEVER LIFTS

LIFT MODEL	BEAM	MAX CAP.	WEIGHT
1284	84"	1200 lbs	210 lbs
2095	95"	2000 lbs	347 lbs

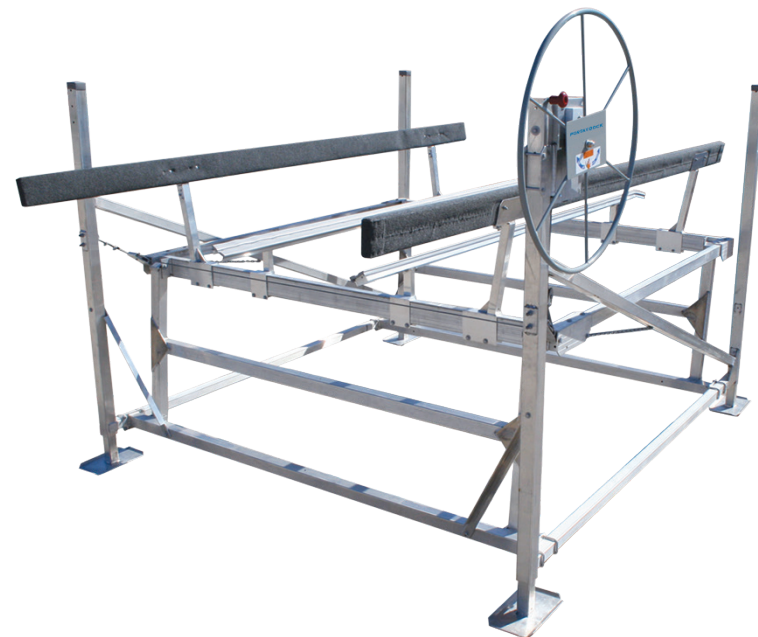

PERSONAL WATERCRAFT LIFTS



1155 DOUBLE PERSONAL WATERCRAFT LIFT

Advantages

- 2200 lb lift capacity (1100 lb per side)
- Continuous lower frame provides rigid support 55" beam per side
- Includes two winches for independent raising and lowering
- Vinyl covered aluminum bunks
- 4 adjustable legs
- Lift wheel included
- Winch motor available



LIFT TYPE	MODEL	BEAM	MAX CAP.	WEIGHT
Cantilever	1155	55"	2200 lbs (1100/side)	336 lbs

We offer a complete line of low maintenance, stylish personal watercraft lifts with adjustable bunk systems and self-braking winches for safe and easy lifting. Porta-Dock's compact, light, and universal lifts are perfect for all models of watercraft. Constructed of high-quality aluminum for maximum strength and durability, our lifts are rustproof, corrosion resistant, and unaffected by weather conditions or UV rays.

1265 CANTILEVER / VERTICAL PERSONAL WATER CRAFT LIFT

- 1200 lb lift capacity
- 65" beam
- Vinyl covered aluminum bunks
- 4 adjustable legs
- Lift wheel included
- Winch motor available

LIFT TYPE	MODEL	BEAM	MAX CAP.	WEIGHT
Cantilever	1265	65"	1200 lbs	200 lbs
Vertical	1265	65"	1200 lbs	185 lbs



1056 CANTILEVER PERSONAL WATERCRAFT LIFT

- 1000 lb lift capacity
- 56" beam
- 4 adjustable legs
- Lift wheel included
- Vinyl covered aluminum bunks
- Winch motor available
- Canopy not available

LIFT TYPE	MODEL	BEAM	MAX CAP.	WEIGHT
Cantilever	1056	56"	1000 lbs	136 lbs



LIFT ACCESSORIES



CANOPY FRAMES & FABRIC

Porta-Dock's lift canopy frames create a "garage-like" enclosure that provides added protection to your watercraft, boat, or pontoon while in the lift. Easy to attach by mounting to existing canopy frame.

Frame

- Adjustable aluminum framework
- Double aluminum tubing runs the full length of the top

Fabric

- Heat-sealed, strong, long-lasting seams
- TOP GUN® acrylic coated polyester marine fabric
- Easily cleans with mild detergent and water
- Comes standard with full-mesh ends

CANOPY COLORS

Porta-Dock TOP GUN® canopies come with a 5-year warranty and offers maximum depth, giving your boat exceptional protection from the elements.

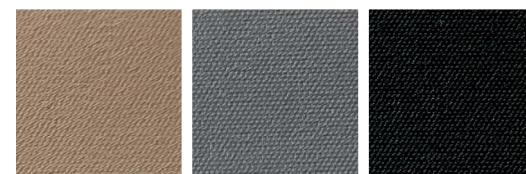

Beige

Charcoal

Onyx

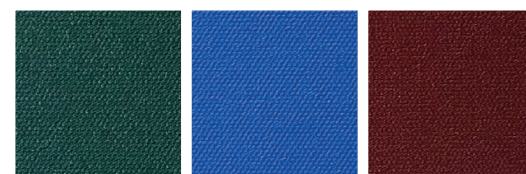

Forest Green

Caribbean Blue

Burgundy

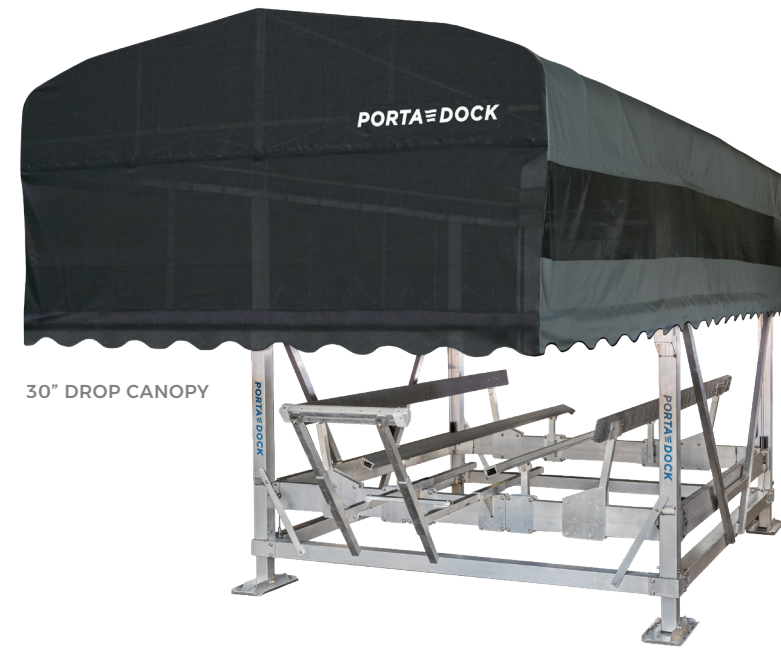

30" DROP CANOPY



Motorized Winch Kits

Designed for optimum strength and ease of use, each motorized winch kit removes the strain from your lift and provides generous clearance and access. Adapts to existing lifts. Available as 12, 24, or 110 volt power. Remotes and solar panels optional on most models. See dealer for details. Available with optional remote and auto-stop.



10 & 20 Watt Solar Panel Systems With Charge Controller

Our solar charging systems are made from high quality, more efficient monocrystalline solar cells that also provide a clean, uniform look. Each panel is enclosed in a screw-less anodized aluminum frame and tempered glass with a water tight junction box and blocking diodes. Mounting arm and brackets included.

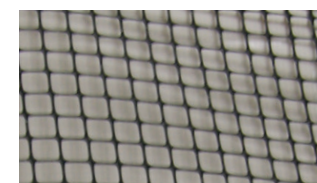

Bird Proof Netting

Durable, lightweight, rot resistant and waterproof mesh prevents birds of all species from nesting under your canopy. Installs in minutes.



Universal Bolt-On Wheel Kit For Lifts (Pair)

Easily attaches to existing lift for convenient installation and removal.



30" Drop Canopy

Our optional 30" drop canopy allows for deeper coverage while still allowing for air to pass through.



Lift Step

Get in and out of your boat safer and easier.



Lift Jack

Provides assistance with lifting and leveling Porta-Dock lifts with the help of a cordless drill by raising a corner of the lift. For use with unloaded lifts, no boat or pontoon on the lift. Includes 30" lift distance along with an independently adjusted arm.

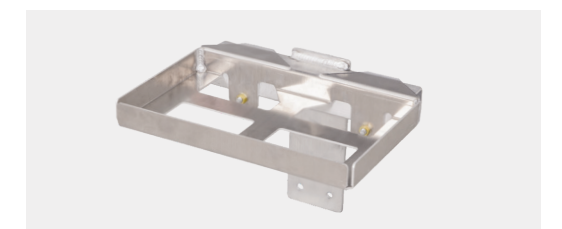

Hanging Battery Tray

Porta-Dock offers a variety of battery trays including single and double trays and frame mountable for lifts with or without canopies. An upright adapter is also available.